

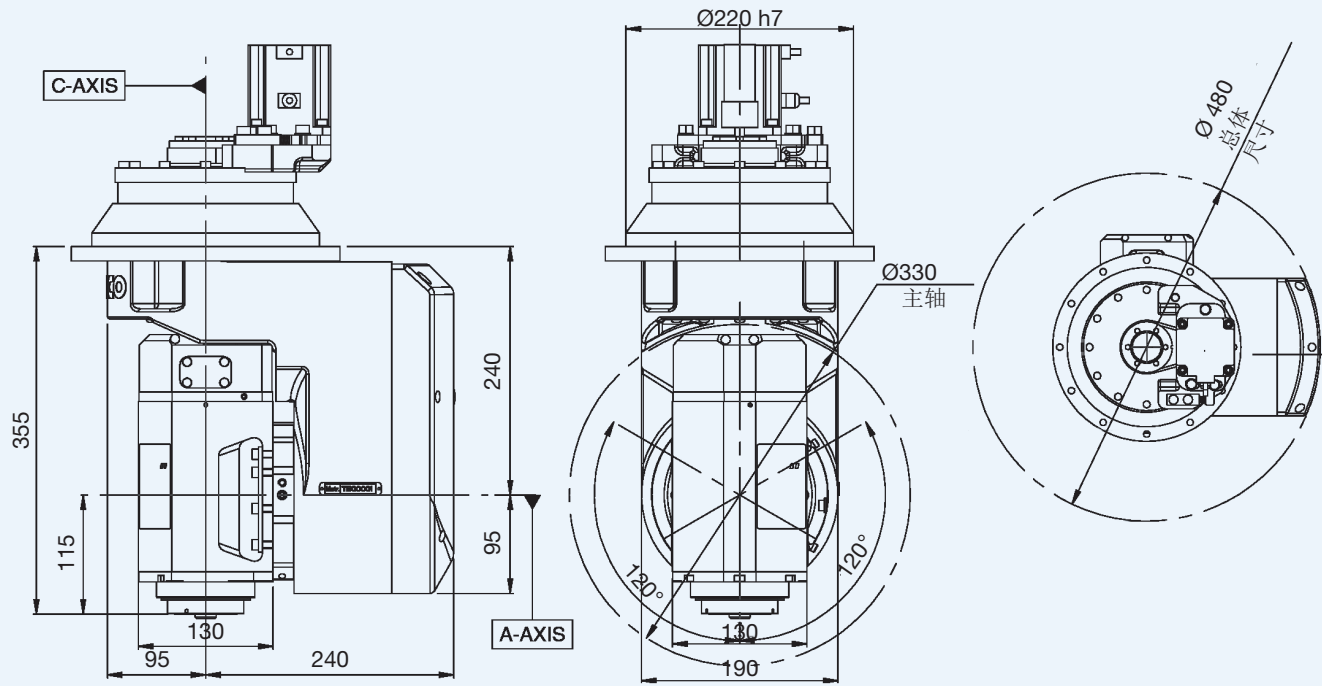



直角类五轴头 TILT J 超高速系列



外形安装尺寸



所配电主轴选配功能

-  轴承温度监控
-  速度监控
-  振动传感器
-  编码器

技术规格

*其他品牌伺服电机可选

	A轴	C轴
伺服电机	Yaskawa*	Yaskawa*
伺服电机功率	0,40 kW	0,40 kW
伺服电机编码器	绝对值 20 Bit	绝对值 20 Bit
减速机品牌	Harmonic Drive	Harmonic Drive
最大连续扭矩	380 Nm	380 Nm
峰值扭矩	570 Nm	570 Nm
最大旋转角度	±120°	±320°
轴上机械刹车	没有	没有
最大定位速度	6.100°/’	6.100°/’
最大工作速度	3.700°/’	3.700°/’
轴定位精度	1 arcmin	1 arcmin
重量		60 kg

可选电主轴

*单元与编码器联用时，布局不同于计划所示

QX-2 8/15 36 40E NC

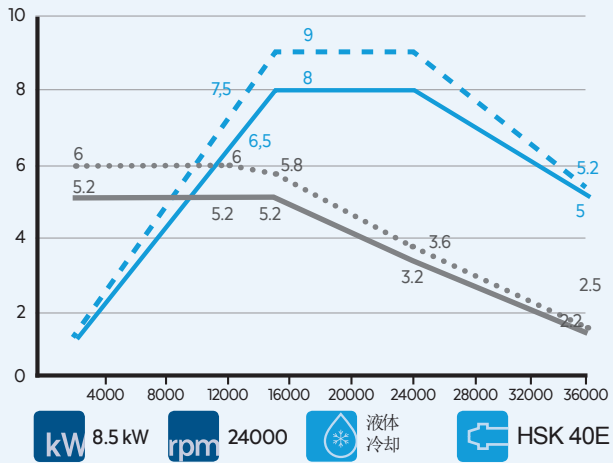

QX-2 8/15 40 32E NC

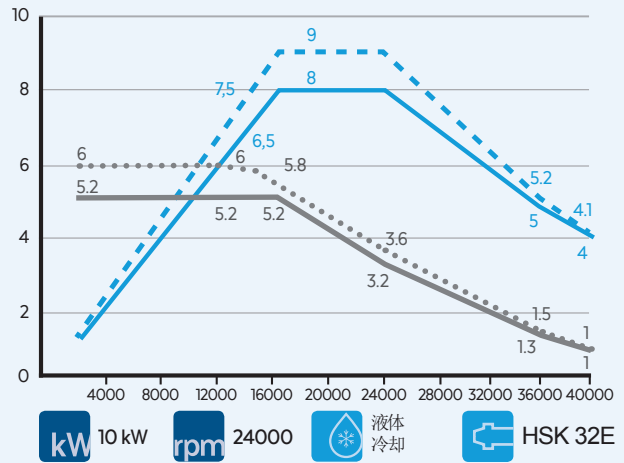

— 功率S1 (KW) — 扭矩S1 (NM) - - - 功率S6 50% (KW) ···· 扭矩S6 50% (NM)